

Intramedullary Nailing

Intramedulläre Nagel

Intramedular Clavado

Endomidollare chiodatura

Intramédullaires clouage



DYNAMIC

D-112-00	Küntscher Instrumentation Set
196-075-30	Container
196-078-30	Tray
112-620-08	Diamond Point Awl. Femur 10 mm
112-625-15	Reamer
112-640-03	Slotted Hammer
112-645-07	Slotted Nail Driver
112-647-08	Nail Driver 6 - 8 mm
112-647-12	Nail Driver 9 -12 mm
112-647-20	Nail Driver 13 - 20 mm
112-675-00	Nail Extractor with 2 hooks & Sliding Mallet
112-200-26	Measuring Gauge
100-602-50	Mallet 500 grams



Küntscher Nails for Femur

Length	6 mm	7 mm	8 mm	9 mm	10 mm	11 mm	12 mm	13 mm	14 mm	15 mm	16 mm	17 mm	18 mm
14 cm	112-006-14	112-007-14											
16 cm	112-006-16	112-007-16											
18 cm	112-006-18	112-007-18											
20 cm	112-006-20	112-007-20											
22 cm	112-006-22	112-007-22											
24 cm	112-006-24	112-007-24	112-008-24										
26 cm	112-006-26	112-007-26	112-008-26										
28 cm	112-006-28	112-007-28	112-008-28										
30 cm	112-006-30	112-007-30	112-008-30	112-009-30									
32 cm	112-006-32	112-007-32	112-008-32	112-009-32	112-010-32	112-011-32							
34 cm	112-006-34	112-007-34	112-008-34	112-009-34	112-010-34	112-011-34	112-012-34	112-013-34	112-014-34				
36 cm	112-006-36	112-007-36	112-008-36	112-009-36	112-010-36	112-011-36	112-012-36	112-013-36	112-014-36	112-015-36	112-016-36	112-017-36	112-018-36
38 cm		112-007-38	112-008-38	112-009-38	112-010-38	112-011-38	112-012-38	112-013-38	112-014-38	112-015-38	112-016-38	112-017-38	112-018-38
40 cm		112-007-40	112-008-40	112-009-40	112-010-40	112-011-40	112-012-40	112-013-40	112-014-40	112-015-40	112-016-40	112-017-40	112-018-40
42 cm			112-008-42	112-009-42	112-010-42	112-011-42	112-012-42	112-013-42	112-014-42	112-015-42	112-016-42	112-017-42	112-018-42
44 cm			112-008-44	112-009-44	112-010-44	112-011-44	112-012-44	112-013-44	112-014-44	112-015-44	112-016-44	112-017-44	112-018-44
46 cm			112-008-46	112-009-46	112-010-46	112-011-46	112-012-46	112-013-46	112-014-46	112-015-46	112-016-46	112-017-46	112-018-46
48 cm			112-008-48	112-009-48	112-010-48	112-011-48	112-012-48	112-013-48	112-014-48	112-015-48	112-016-48	112-017-48	112-018-48
50 cm			112-008-50	112-009-50	112-010-50	112-011-50	112-012-50	112-013-50	112-014-50	112-015-50	112-016-50	112-017-50	112-018-50
52 cm				112-009-52	112-010-52	112-011-52	112-012-52	112-013-52	112-014-52	112-015-52	112-016-52	112-017-52	112-018-52



Küntscher Nails for Humerus & Tibia.

Length	6 mm	7 mm	8 mm	9 mm	10 mm	11 mm	12 mm	13 mm	14 mm
18 cm	112-106-18	112-107-18	112-108-18	112-109-18	112-110-18	112-111-18	112-112-18	112-113-18	
19 cm	112-106-19	112-107-19	112-108-19	112-109-19	112-110-19	112-111-19	112-112-19	112-113-19	
20 cm	112-106-20	112-107-20	112-108-20	112-109-20	112-110-20	112-111-20	112-112-20	112-113-20	
21 cm	112-106-21	112-107-21	112-108-21	112-109-21	112-110-21	112-111-21	112-112-21	112-113-21	
22 cm	112-106-22	112-107-22	112-108-22	112-109-22	112-110-22	112-111-22	112-112-22	112-113-22	
23 cm	112-106-23	112-107-23	112-108-23	112-109-23	112-110-23	112-111-23	112-112-23	112-113-23	
24 cm	112-106-24	112-107-24	112-108-24	112-109-24	112-110-24	112-111-24	112-112-24	112-113-24	
25 cm	112-106-25	112-107-25	112-108-25	112-109-25	112-110-25	112-111-25	112-112-25	112-113-25	
26 cm	112-106-26	112-107-26	112-108-26	112-109-26	112-110-26	112-111-26	112-112-26	112-113-26	
27 cm	112-106-27	112-107-27	112-108-27	112-109-27	112-110-27	112-111-27	112-112-27	112-113-27	
28 cm	112-106-28	112-107-28	112-108-28	112-109-28	112-110-28	112-111-28	112-112-28	112-113-28	
29 cm	112-106-29	112-107-29	112-108-29	112-109-29	112-110-29	112-111-29	112-112-29	112-113-29	
30 cm	112-106-30	112-107-30	112-108-30	112-109-30	112-110-30	112-111-30	112-112-30	112-113-30	112-114-30
31 cm		112-107-31	112-108-31	112-109-31	112-110-31	112-111-31	112-112-31	112-113-31	112-114-31
32 cm		112-107-32	112-108-32	112-109-32	112-110-32	112-111-32	112-112-32	112-113-32	112-114-32
33 cm		112-107-33	112-108-33	112-109-33	112-110-33	112-111-33	112-112-33	112-113-33	112-114-33
34 cm		112-107-34	112-108-34	112-109-34	112-110-34	112-111-34	112-112-34	112-113-34	112-114-34
35 cm		112-107-35	112-108-35	112-109-35	112-110-35	112-111-35	112-112-35	112-113-35	112-114-35
36 cm		112-107-36	112-108-36	112-109-36	112-110-36	112-111-36	112-112-36	112-113-36	112-114-36
37 cm		112-107-37	112-108-37	112-109-37	112-110-37	112-111-37	112-112-37	112-113-37	112-114-37
38 cm		112-107-38	112-108-38	112-109-38	112-110-38	112-111-38	112-112-38	112-113-38	112-114-38
39 cm		112-107-39	112-108-39	112-109-39	112-110-39	112-111-39	112-112-39	112-113-39	112-114-39
40 cm		112-107-40	112-108-40	112-109-40	112-110-40	112-111-40	112-112-40	112-113-40	112-114-40

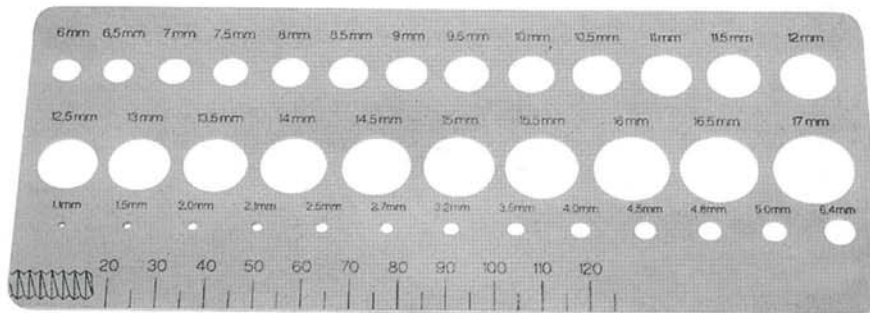

112-200-26 Measuring Gauge for Nails

- 112-224-90** Guide Rod 2.4 mm, length 90 cm
112-230-90 Guide Rod 3.0 mm, length 90 cm

- 112-320-90** Guide Rod 2.0 mm, length 90 cm
112-330-90 Guide Rod 3.0 mm, length 90 cm

Guide Pin for Küntscher Nails

- 112-530-60** Guide Pin 3.0 mm Ø 60 cm long
112-535-60 Guide Pin 3.5 mm Ø 60 cm long
112-540-60 Guide Pin 4.0 mm Ø 60 cm long
112-550-60 Guide Pin 5.0 mm Ø 60 cm long

Reamer for küntscher Nails

- | | | | | | | | | |
|-------------------|-------------------|-------------------|-------------------|-------------------|-------------------|-------------------|-------------------|-------------------|
| Ø 6,0 mm | 7,0 mm | 8,0 mm | 9,0 mm | 10,0 mm | 11,0 mm | 12,0 mm | 13,0 mm | 14,0 mm |
| 112-600-06 | 112-600-07 | 112-600-08 | 112-600-09 | 112-600-10 | 112-600-11 | 112-600-12 | 112-600-13 | 112-600-14 |
| Ø 15,0 mm | 16,0 mm | 17,0 mm | 18,5 mm | 19,0 mm | 20,0 mm | | | |
| 112-600-15 | 112-600-16 | 112-600-17 | 112-600-18 | 112-600-19 | 112-600-20 | | | |

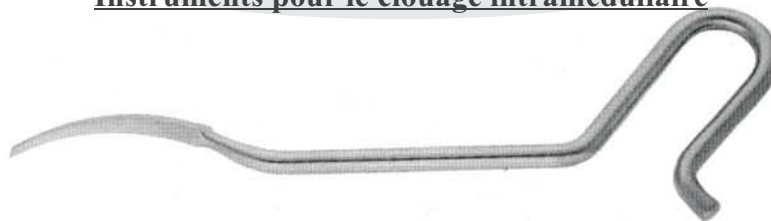

112-620-08 Diamond Point Awl. Tibia 8 mm
112-620-10 Diamond Point Awl. Femur 10 mm

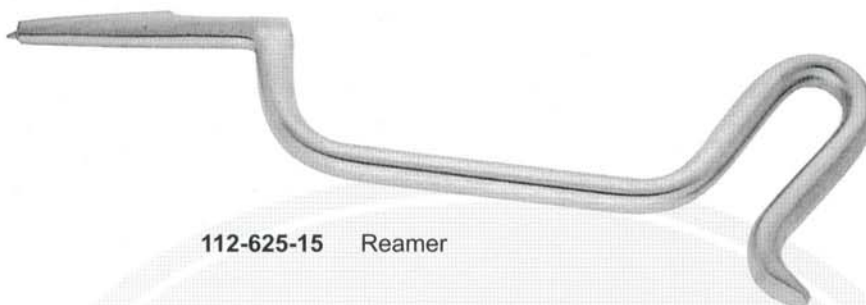

112-625-15 Reamer



112-630-12 Cannulated Awl 3.2 mm



112-640-03 Slotted Hammer



112-642-10 Slotted Hammer 14 mm



112-645-07 Slotted Nail Driver



112-647-08 Nail Driver for Nails 6 - 8 Ø

112-647-12 Nail Driver for Nails 9 - 12 Ø

112-647-20 Nail Driver for Nails 13 - 20 Ø

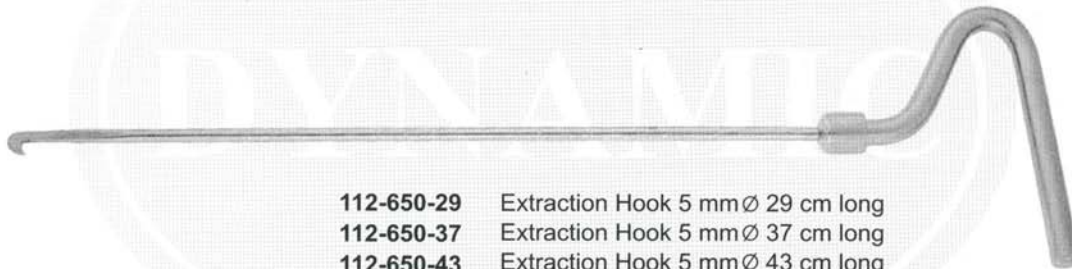

112-650-29 Extraction Hook 5 mm Ø 29 cm long

112-650-37 Extraction Hook 5 mm Ø 37 cm long

112-650-43 Extraction Hook 5 mm Ø 43 cm long

112-650-51 Extraction Hook 5 mm Ø 51 cm long

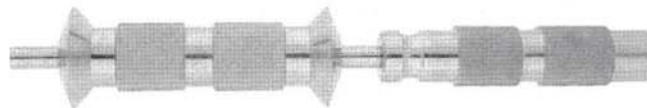

112-675-00 Nail Extractor with 2 Hooks and Sliding Mallet



112-675-05 Small Hook only



112-675-10 Large Hook only



113-064-00	Rush Medullary Pin 6,4 Ø complete set	9	Pin with Rack
113-048-00	Rush Medullary Pin 4,8 Ø complete set	9	Pin with Rack
113-032-00	Rush Medullary Pin 3,2 Ø complete set	13	Pin with Rack
113-024-00L	Rush Medullary Pin 2,4 Ø complete set	13	Large Pins with Rack
113-024-00S	Rush Medullary Pin 2,4 Ø complete set	13	Small Pins with Rack

113-164-00	Rack for Rush Medullary Set pin 6,4 Ø
113-148-00	Rack for Rush Medullary Set pin 4,8 Ø
113-132-00	Rack for Rush Medullary Set pin 3,2 Ø
113-124-00	Rack for Rush Medullary Set pin 2,4 Ø



Individual Pins

6,4 Ø	280 mm	295 mm	315 mm	335 mm	355 mm	375 mm	395 mm	410 mm	430 mm long
	113-064-28	113-064-29	113-064-31	113-064-33	113-064-35	113-064-37	113-064-39	113-064-41	113-064-43
4,8 Ø	205 mm	220 mm	240 mm	255 mm	280 mm	295 mm	315 mm	335 mm	355 mm long
	113-048-20	113-048-22	113-048-24	113-048-25	113-048-28	113-048-29	113-048-31	113-048-33	113-048-35
3,2 Ø	100 mm	115 mm	125 mm	140 mm	150 mm	165 mm	180 mm	190 mm	205 mm long
	113-032-10	113-032-11	113-032-12	113-032-14	113-032-15	113-032-16	113-032-18	113-032-19	113-032-20
	215 mm	235 mm	240 mm	255 mm	length				
	113-032-21	113-032-23	113-032-24	113-032-25					
2,4 Ø	25 mm	30 mm	40 mm	45 mm	50 mm	60 mm	65 mm	70 mm	75 mm
	113-024-25	113-024-30	113-024-40	113-024-45	113-024-50	113-024-60	113-024-65	113-024-70	113-024-75
	85 mm	90 mm	95 mm	100 mm					
	113-024-85	113-024-90	113-024-95	113-024-96					
	115 mm	125 mm	140 mm	150 mm	165 mm	180 mm	190 mm	205 mm	215 mm
	113-025-11	113-025-12	113-025-14	113-025-15	113-025-16	113-025-18	113-025-19	113-025-20	113-025-21
	230 mm	240 mm	255 mm	length					
	113-025-23	113-025-24	113-025-25						



113-364-08	Driver and Extractor 6,4 mm Ø
113-348-12	Driver and Extractor 4,8 mm Ø
113-332-16	Driver and Extractor 3,2 mm Ø
113-324-20	Driver and Extractor 2,4 mm Ø

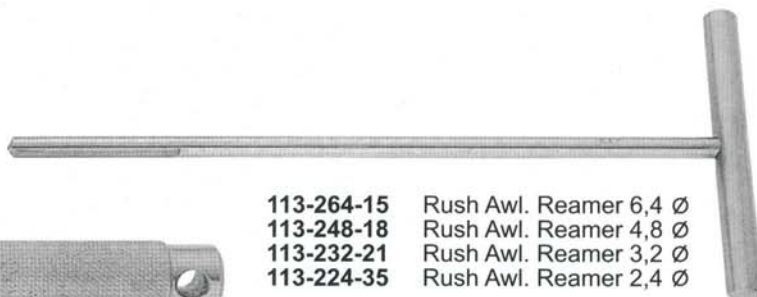

113-264-15	Rush Awl. Reamer 6,4 Ø
113-248-18	Rush Awl. Reamer 4,8 Ø
113-232-21	Rush Awl. Reamer 3,2 Ø
113-224-35	Rush Awl. Reamer 2,4 Ø



113-400-02 Bender

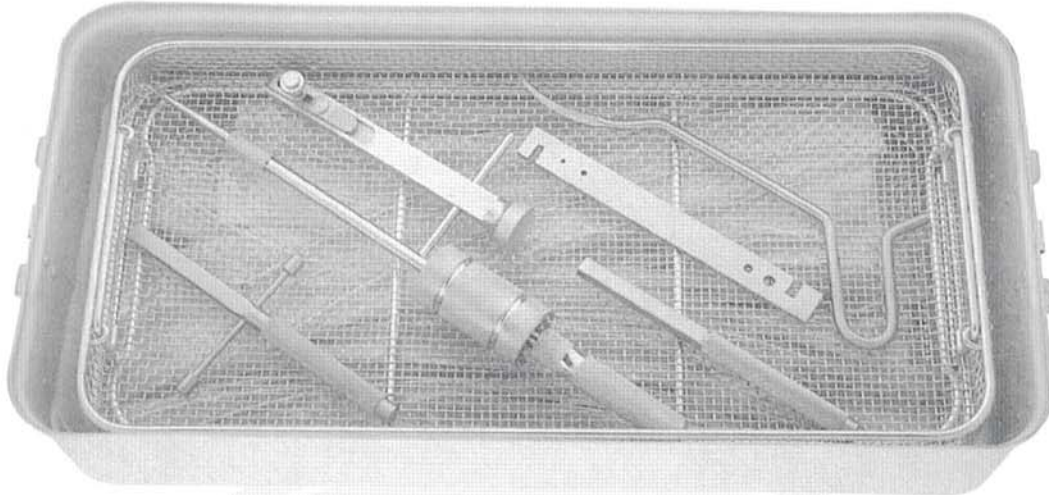

D-113-05 Ender Nail Set
196-078-00 Container
196-078-00 Tray- upper
196-078-00 Tray - Lower

113-545-30	3 Flexible Medullary Nails 300 mm
113-545-31	3 Flexible Medullary Nails 310 mm
113-545-32	3 Flexible Medullary Nails 320 mm
113-545-33	3 Flexible Medullary Nails 330 mm
113-545-34	3 Flexible Medullary Nails 340 mm
113-545-35	3 Flexible Medullary Nails 350 mm
113-545-36	3 Flexible Medullary Nails 360 mm
113-545-37	3 Flexible Medullary Nails 370 mm
113-545-38	3 Flexible Medullary Nails 380 mm
113-545-39	3 Flexible Medullary Nails 390 mm
113-545-40	3 Flexible Medullary Nails 400 mm
113-545-41	3 Flexible Medullary Nails 410 mm
113-545-42	3 Flexible Medullary Nails 420 mm
113-545-43	3 Flexible Medullary Nails 430 mm
113-545-44	3 Flexible Medullary Nails 440 mm
113-545-45	3 Flexible Medullary Nails 450 mm
113-545-46	3 Flexible Medullary Nails 460 mm
113-545-47	3 Flexible Medullary Nails 470 mm
113-545-48	3 Flexible Medullary Nails 480 mm
113-545-49	3 Flexible Medullary Nails 490 mm

113-570-25	1 Nail Inserter
113-580-12	1 Impactor
113-400-02	1 Bender
113-590-35	1 Impactor- Extractor
113-592-40	1 Extractor
112-620-10	1 Awl, Cortical, 10 mm

**DYNAMIC
INSTRUMENTS**

Flexible Medullary Nails / Instruments
Flexible Marknägel / Instrumente
Flexible Nails medular / Instrumentos
Flessibile Nails midollare / Strumenti
Flexible Nails médullaire / Instruments

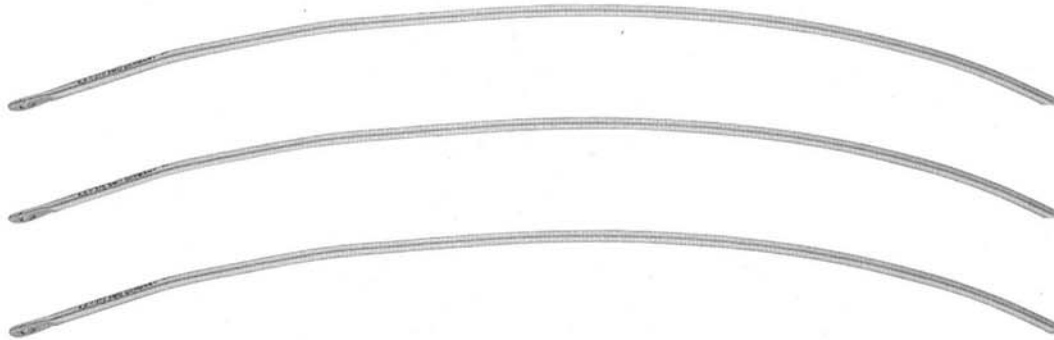

300 mm	310 mm	320 mm	330 mm	340 mm	350 mm	360 mm	370 mm	380 mm	390 mm
113-545-30	113-545-31	113-545-32	113-545-33	113-545-34	113-545-35	113-545-36	113-545-37	113-545-38	113-545-39
400 mm	410 mm	420 mm	430 mm	440 mm	450 mm	460 mm	470 mm	480 mm	490 mm
113-545-40	113-545-41	113-545-42	113-545-43	113-545-44	113-545-45	113-545-46	113-545-47	113-545-48	113-545-49



113-570-25 Nail Inserter

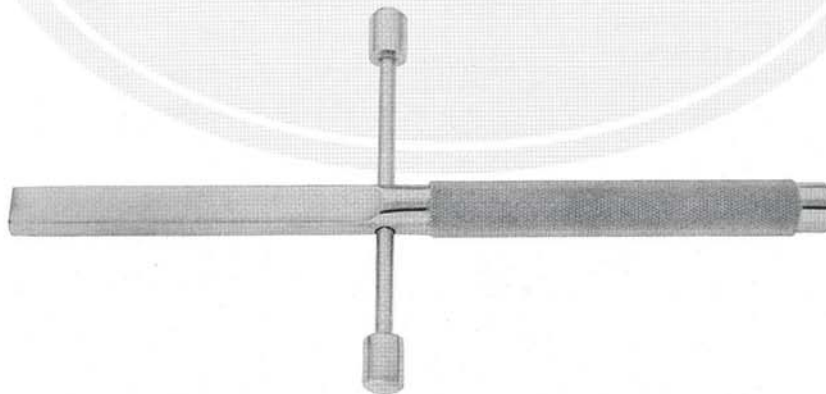

113-580-12 Impactor



113-400-02 Bender

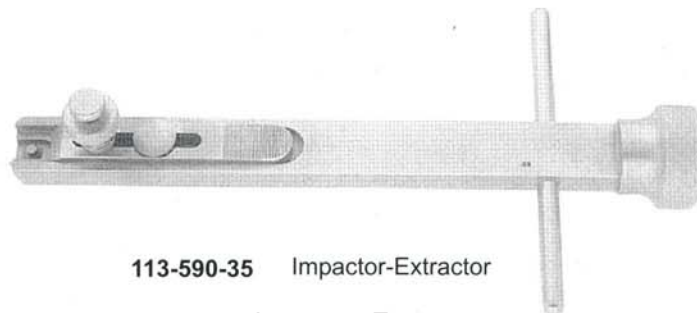

113-590-35 Impactor-Extractor

Impactor-Extractor
Impattatore-Estrattore
113-590-35

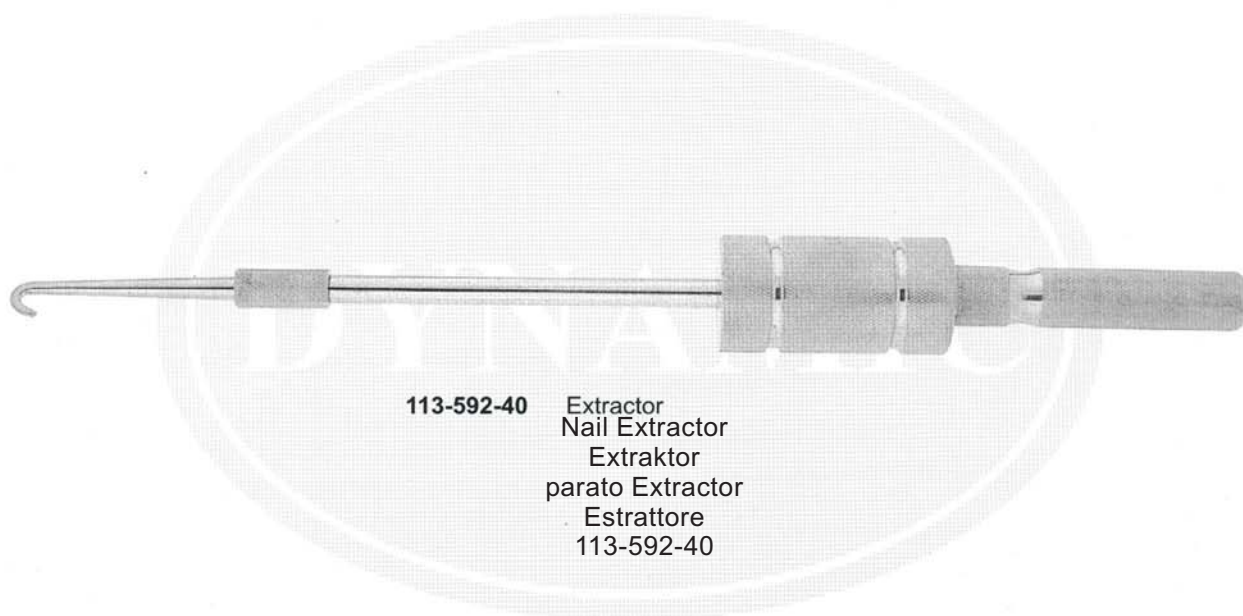

113-592-40 Extractor
Nail Extractor
Extraktor
parato Extractor
Estrattore
113-592-40

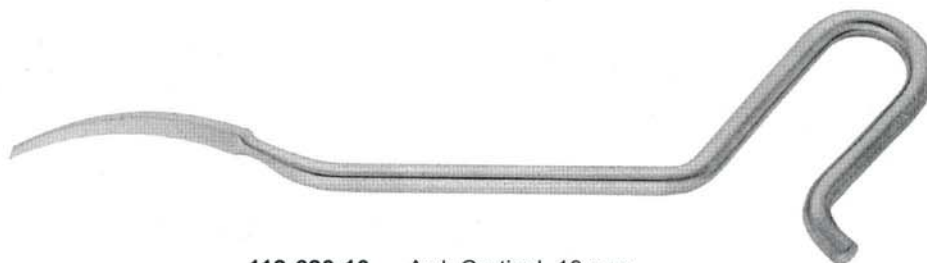

112-620-10 Awl, Cortical, 10 mm



**Unreamed Femoral Interlocking Nails
(Reaming of bone not Required)**

Cat. No	Ømm	Length cm
114-008-24	8	24
114-008-26	8	26
114-008-28	8	28
114-008-30	8	30
114-008-32	8	32
114-008-34	8	34
114-008-36	8	36
114-008-38	8	38
114-009-24	9	24
114-009-26	9	26
114-009-28	9	28
114-009-30	9	30
114-009-32	9	32
114-009-34	9	34
114-009-36	9	36
114-009-38	9	38
114-009-40	9	40
114-009-42	9	42
114-009-44	9	44
114-009-46	9	46
114-010-24	10	24
114-010-26	10	26
114-010-28	10	28
114-010-30	10	30
114-010-32	10	32
114-010-34	10	34
114-010-36	10	36
114-010-38	10	38
114-010-40	10	40
114-010-42	10	42
114-010-44	10	44
114-010-46	10	46
114-010-48	10	48
114-011-32	11	32
114-011-34	11	34
114-011-36	11	36
114-011-38	11	38
114-011-40	11	40
114-011-42	11	42
114-011-44	11	44
114-011-46	11	46
114-011-48	11	48

Screw Plugs for Femur



Cat. No.	Ømm
114-020-13	13

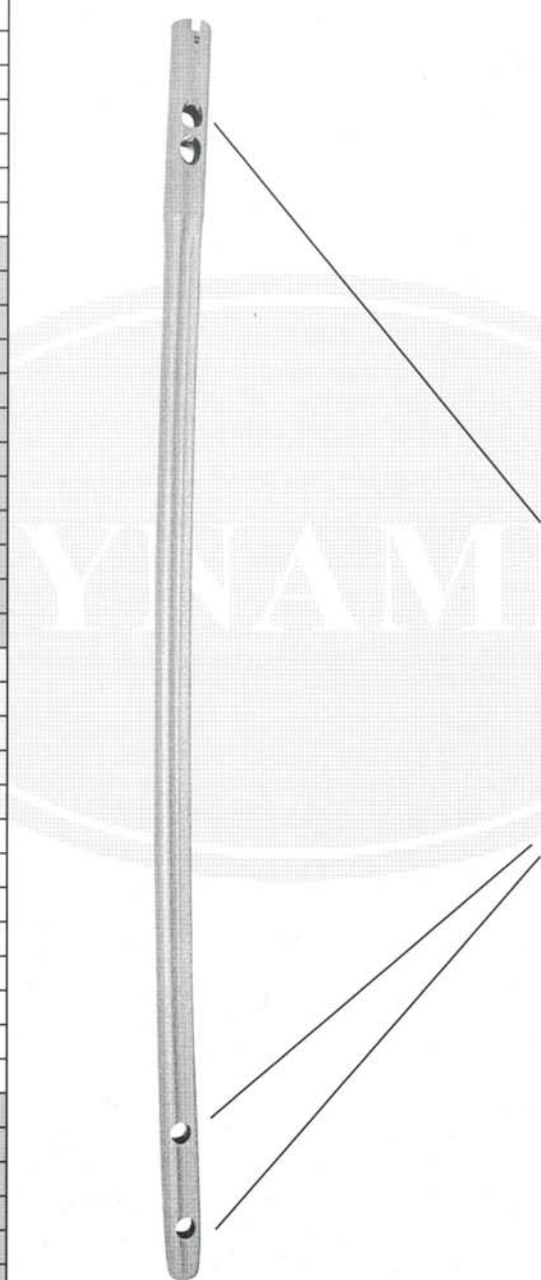

**Locking Screw Ø 5.0 mm
for proximal and distal holes**



Cat. No.	Length cm
114-050-30	30
114-050-35	35
114-050-40	40
114-050-45	45
114-050-50	50
114-050-55	55
114-050-60	60
114-050-65	65
114-050-70	70
114-050-75	75
114-050-80	80
114-050-85	85
114-050-90	90



Standard Femoral Interlocking Nails

Cat. No	∅mm	Length cm
114-012-32	12	32
114-012-34	12	34
114-012-36	12	36
114-012-38	12	38
114-012-40	12	40
114-012-42	12	42
114-012-44	12	44
114-012-46	12	46
114-012-48	12	48
114-012-50	12	50
114-013-36	13	36
114-013-38	13	38
114-013-40	13	40
114-013-42	13	42
114-013-44	13	44
114-013-46	13	46
114-013-48	13	48
114-013-50	13	50
114-014-36	14	36
114-014-38	14	38
114-014-40	14	40
114-014-42	14	42
114-014-44	14	44
114-014-46	14	46
114-014-48	14	48

Screw Plugs for Femur



Cat. No.	∅mm
114-020-13	13

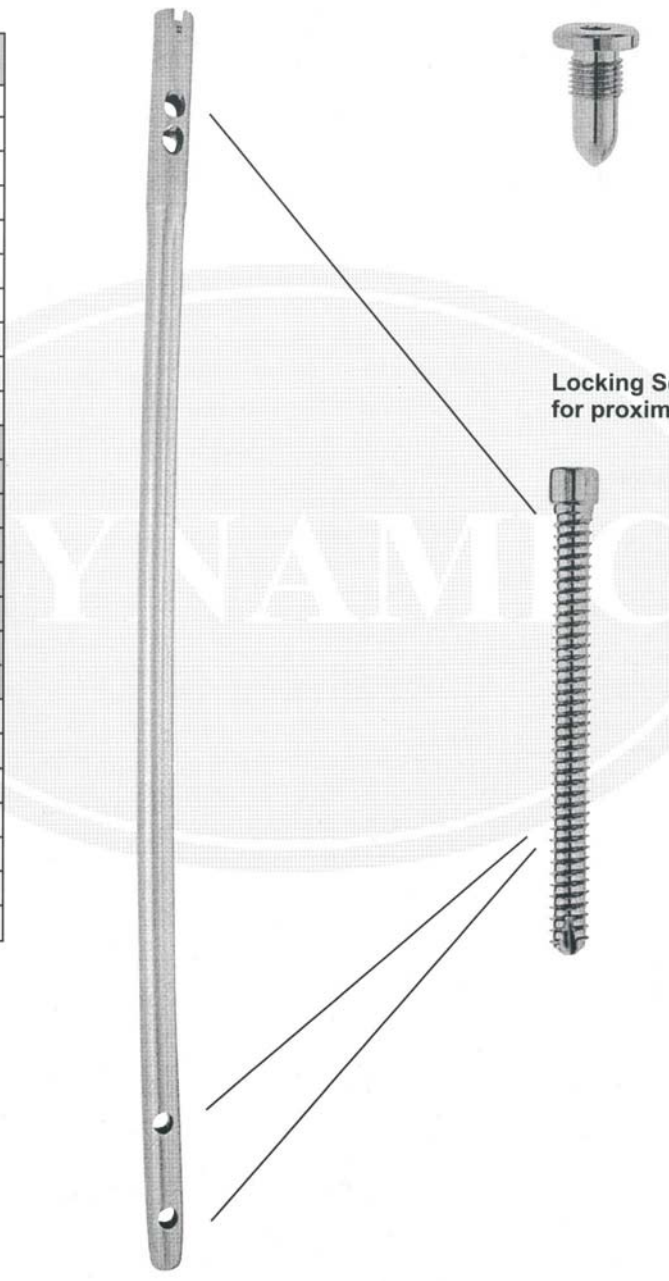

**Locking Screw ∅6.4 mm
for proximal and distal holes**



Cat. No.	Length cm
114-064-30	30
114-064-35	35
114-064-40	40
114-064-45	45
114-064-50	50
114-064-55	55
114-064-60	60
114-064-65	65
114-064-70	70
114-064-75	75
114-064-80	80
114-064-85	85
114-064-90	90



**Unreamed Tibial Interlocking Nails
(Reaming of bone not required)**

Cat. No	Ømm	Length cm
114-108-27	8	27.0
114-108-28	8	28.5
114-108-30	8	30.0
114-108-31	8	31.5
114-108-33	8	33.0
114-108-34	8	34.5
114-108-36	8	36.0
114-108-38	8	38.0
114-108-40	8	40.0
114-108-42	8	42.0
114-109-27	9	27.0
114-109-28	9	28.5
114-109-30	9	30.0
114-109-31	9	31.5
114-109-33	9	33.0
114-109-34	9	34.5
114-109-36	9	36.0
114-109-38	9	38.0
114-109-40	9	40.0
114-109-42	9	42.0
114-109-44	9	44.0
114-110-27	10	27.0
114-110-28	10	28.5
114-110-30	10	30.0
114-110-31	10	31.5
114-110-33	10	33.0
114-110-34	10	34.5
114-110-36	10	36.0
114-110-38	10	38.0
114-110-40	10	40.0
114-110-42	10	42.0
114-110-44	10	44.0

Screw Plugs for Tibia



Cat. No.	Ømm
114-120-12	12



**Locking Screws Ø 4.5 mm
for proximal and distal holes**



Cat. No.	Length cm
114-045-20	20
114-045-25	25
114-045-30	30
114-045-35	35
114-045-40	40
114-045-45	45
114-045-50	50
114-045-55	55
114-045-60	60
114-045-65	65



Standard Tibial Interlocking Nails

Cat. No	Ømm	Length cm
114-111-27	11	27.0
114-111-28	11	28.5
114-111-30	11	30.0
114-111-31	11	31.5
114-111-33	11	33.0
114-111-34	11	34.5
114-111-36	11	36.0
114-111-38	11	38.0
114-111-40	11	40.0
114-111-42	11	42.0
114-112-28	12	28.5
114-112-30	12	30.0
114-112-31	12	31.5
114-112-33	12	33.0
114-112-34	12	34.5
114-112-36	12	36.0
114-112-38	12	38.0
114-112-40	12	40.0
114-112-42	12	42.0
114-113-28	13	28.5
114-113-30	13	30.0
114-113-31	13	31.5
114-113-33	13	33.0
114-113-34	13	34.5
114-113-36	13	36.0
114-113-38	13	38.0
114-114-30	14	30.0
114-114-31	14	31.5
114-114-33	14	33.0
114-114-34	14	34.5
114-114-36	14	36.0
114-114-38	14	38.0

Screw Plugs for Tibia



Cat. No.	Ømm
114-120-12	12

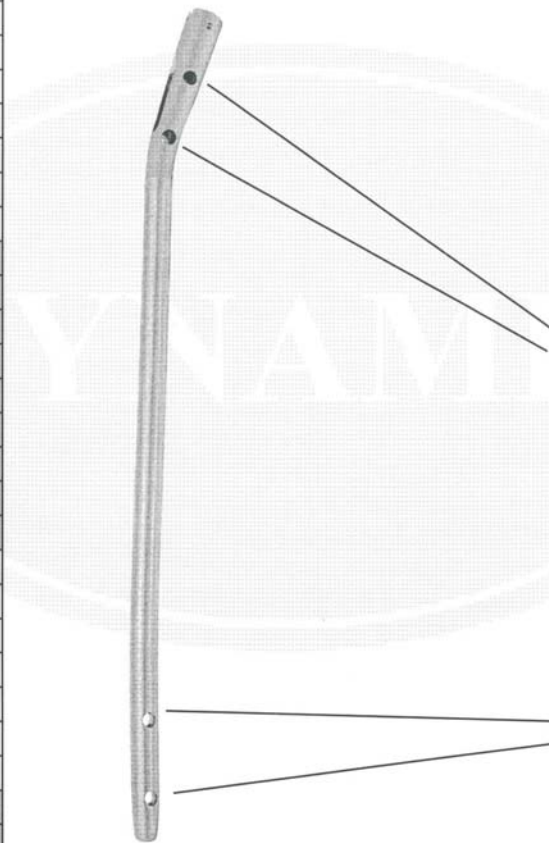

**Locking Screws Ø 5.0 mm
for proximal and distal locking**



Cat. No.	Length cm
114-050-25	25
114-050-30	30
114-050-35	35
114-050-40	40
114-050-45	45
114-050-50	50
114-050-55	55
114-050-60	60
114-050-65	65
114-050-70	70
114-050-75	75
114-050-80	80
114-050-85	85
114-050-90	90



D-114-005 Instrument Set for Interlocking Nail System
196-075-00 Container
196-080-03 Tray - Set of 3

114-400-07	Universal Socket Wrench
114-425-64	Hex Driver for 6,4 mm Screws (Cannulated Hex Driver)
114-425-45	Hex Driver for 5,0 mm Screws (Cannulated Hex Driver)
114-448-12	Medullary Exchange Tube
114-422-10	Depth Gauge
114-452-27	Twist Drill, 2,7 mm, Length 305 mm
114-452-35	Twist Drill, 3,5 mm, Length 305 mm
114-452-40	Twist Drill, 4,0 mm, Length 305 mm
114-452-48	Twist Drill, 4,8 mm, Length 305 mm
114-453-24	Trocar 4,0 mm x 240 mm
114-454-32	Tip Threaded Guide Pin, 3,2 mm x 305 mm
114-455-20	Guide Rod, 2,0 mm x 305 mm
114-403-14	Open End Wrench SW 17 / 19
114-417-04	Percutaneous Knife Handle
114-465-88	Reamer / Nail / screw Template
114-468-90	Nail Length Gauge
114-435-03	Screw Length Gauge
114-409-05	Supine Driver
100-040-01	Reamer Guide Rod Holder
114-438-02	Tibial Proximal Drill Guide
114-432-01	Skin Protector
114-428-04	Curved Awl 13 mm
114-460-80	Dill Sleeve (long) Ø 8.0 mm
114-460-40	Dill Sleeve (short) Ø 8.0 mm
114-461-21	Dill Sleeve 2.1 mm
114-461-48	Drill Sleeve 4.8 mm
114-461-40	Drill Sleeve 4.0 mm
114-461-35	Drill Sleeve 3.5 mm
114-461-32	Drill Sleeve 3.2 mm
114-442-03	Proximal Drill Guide for Femoral Nails
114-642-10	Slotted Hammer
114-406-02	Slide Hammer
114-444-23	Tibial Extractor Bolt
114-412-01	Driver Extractor Tube



Tray No.1

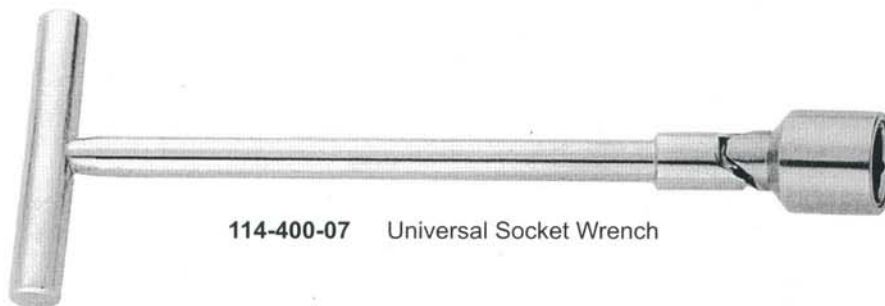

114-400-07 Universal Socket Wrench

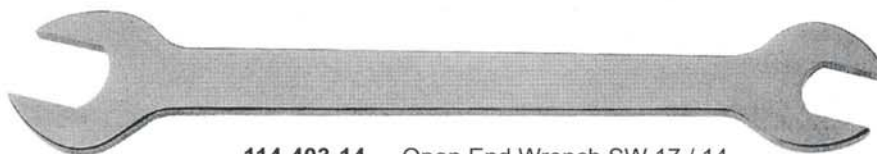

114-403-14 Open End Wrench SW 17 / 14



114-406-02 Slide Hammer



114-409-05 Supine Driver

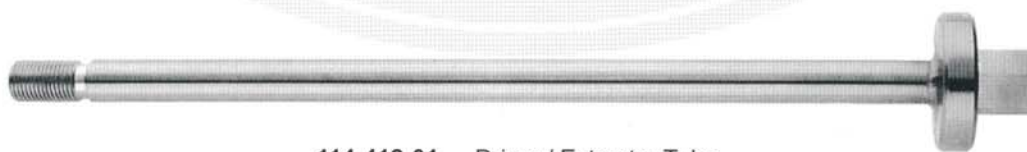

114-412-01 Driver / Extractor Tube

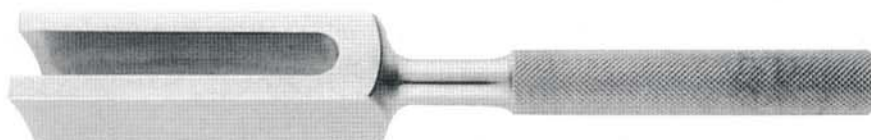

112-642-10 Slotted Hammer 14 mm



114-417-04 Percutaneous Knife Handle



Tray No.2



114-422-10 Depth Gauge

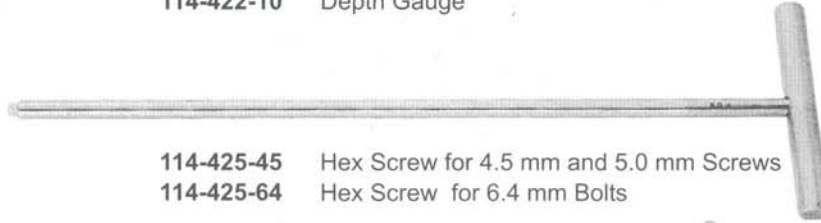

114-425-45 Hex Screw for 4.5 mm and 5.0 mm Screws
114-425-64 Hex Screw for 6.4 mm Bolts



114-428-04 Curved Awl 13 mm

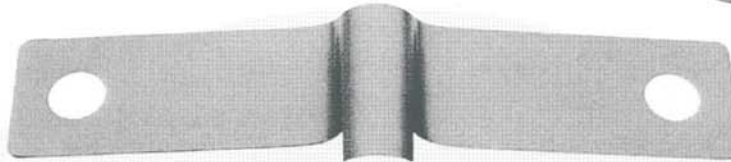

114-432-01 Skin Protector



114-435-03 Screw Length Gauge



114-438-02 Proximal Drill Guide for Tibial Nails



114-442-03 Proximal Drill Guide for Femoral Nails



114-444-23 Tibial Extractor Bolt



Tray No.3



114-448-12 Medullary Exchange Tube



Twist Drills Length 305 mm

Cat. No.	∅ mm
114-452-27	2,7
114-452-35	3,5
114-452-40	4,0
114-452-48	4,8



114-453-24 Trocar ∅4.0 mm x 240



114-454-32 Tip Threaded Guide Pin 3.2 mm x 305 mm (recommended)



114-455-20 Trocar ∅4.0 mm x 240



114-460-80 Green Drill Sleeve ∅8.0 mm



- 114-461-21** Drill Sleeve ∅ 2.1 mm
- 114-461-32** Drill Sleeve ∅ 3.2 mm
- 114-461-35** Drill Sleeve ∅ 3.5 mm
- 114-461-40** Drill Sleeve ∅ 4.0 mm
- 114-461-48** Drill Sleeve ∅ 4.8 mm

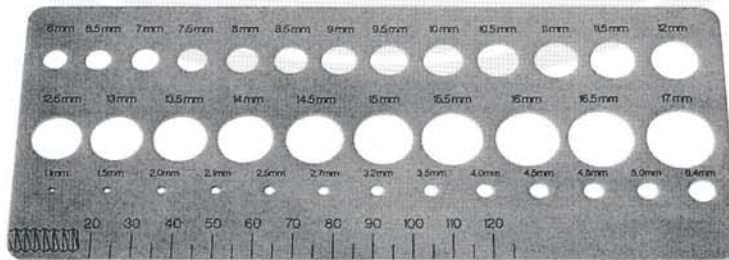

114-465-88 Reamer / Nail and Screw Template



114-468-90 Nail Length Gauge



100-040-01 Reamer Guide Rod Holder

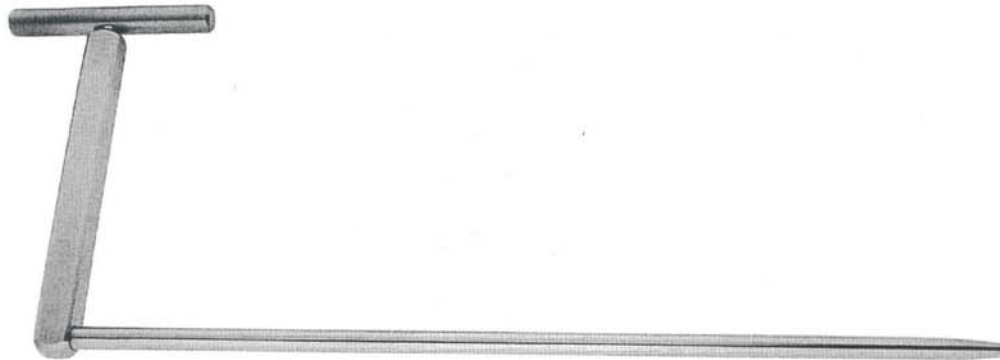

114-472-05 Internal Fracture Alignment Device



Drill Bits Cannulated hole \varnothing 2,1 mm Length 150 mm

Cat. No.	\varnothing mm
114-475-35	3.5
114-475-40	4.0
114-475-48	4.8



Drill Bits Length 150 mm

Cat. No.	\varnothing mm
114-476-27	2.7
114-476-35	3.5
114-476-40	4.0
114-476-48	4.8

-
- 114-480-24** Guide Rod for IM Nail, \varnothing 2,4 mm Length 900 mm
114-480-32 Guide Rod for IM Nail, \varnothing 3,2 mm Length 900 mm

-
- 114-482-30** Guide Rod for Reamer, \varnothing 3,0 mm Length 900 mm with \varnothing 4,0 mm Spade Tip

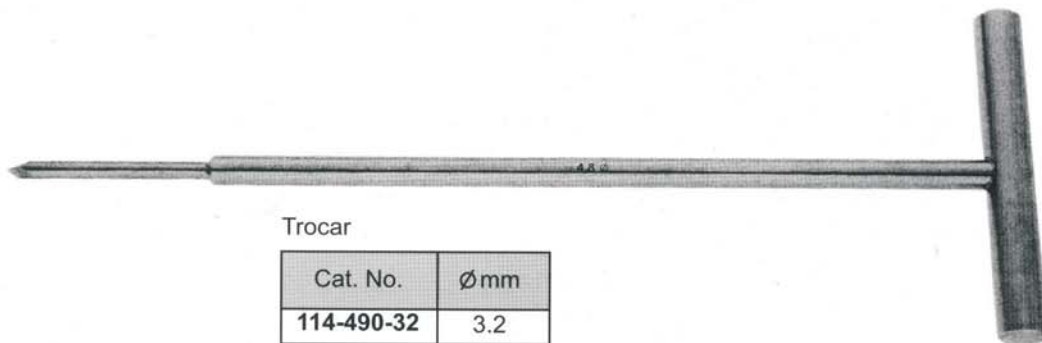

Trocar

Cat. No.	\varnothing mm
114-490-32	3.2
114-490-40	4.0
114-490-48	4.8
114-490-80	8.0



Humeral Interlocking Nails

Cat. No	Ømm	Length cm
114-207-18	7	18
114-207-20	7	20
114-207-22	7	22
114-207-24	7	24
114-207-26	7	26
114-207-28	7	28
114-207-30	7	30
114-208-18	8	18
114-208-20	8	20
114-208-22	8	22
114-208-24	8	24
114-208-26	8	26
114-208-28	8	28
114-208-30	8	30
114-209-18	9	18
114-209-20	9	20
114-209-22	9	22
114-209-24	9	24
114-209-26	9	26
114-209-28	9	28
114-209-30	9	30

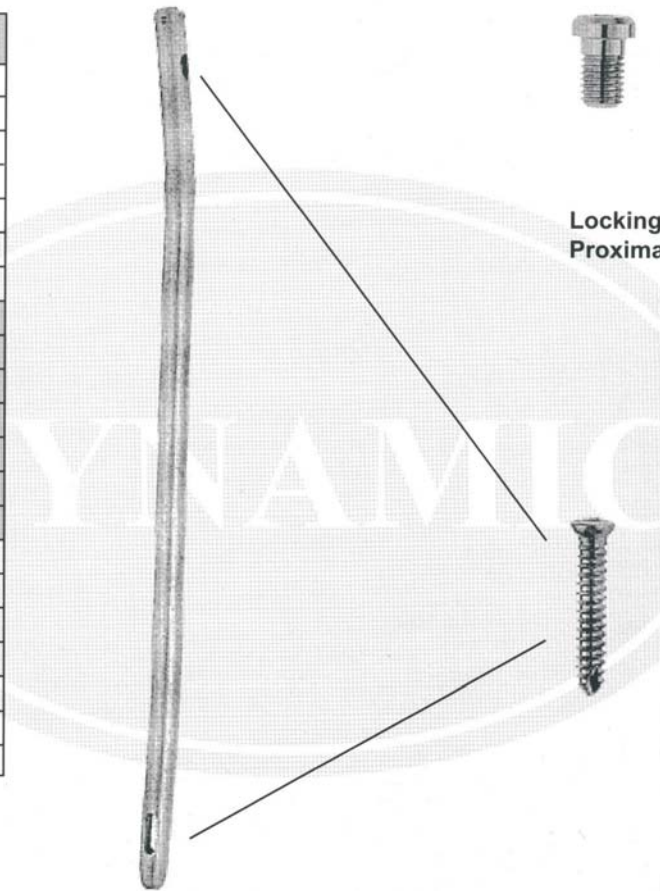

Screw Plug Threaded 1/4"



Cat. No.	Ømm
114-220-10	10

Locking Screws Ø 4.0 mm for Proximal & distal holes

Cat. No.	Length cm
114-240-10	10
114-240-12	12
114-240-14	14
114-240-16	16
114-240-18	18
114-240-20	20
114-240-22	22
114-240-24	24
114-240-26	26
114-240-28	28
114-240-30	30
114-240-32	32
114-240-35	35
114-240-40	40
114-240-45	45
114-240-50	50
114-240-55	55
114-240-60	60



**Humeral interlocking Instrumentation
(Only for Humerus - not included in Basic Set)**



114-525-02 Humeral Proximal Drill Guide



114-532-55 Adapter for Nail Driver and
extractor (1-19220)



114-545-27 Humeral Drill Sleeve 2,7 mm short



114-546-60 Humeral Drill Sleeve 6,0 mm short



114-548-27 Drill Bit Dia. 2,7 Length 150 mm

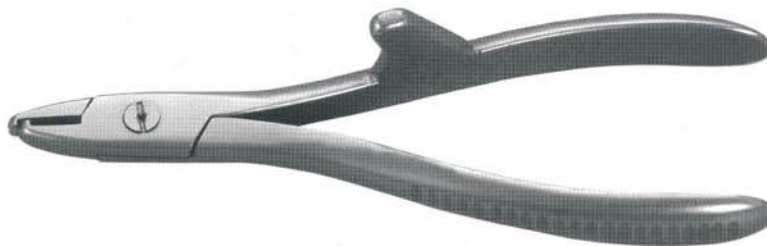

114-560-16 Nail Extractor 165 mm
with Longitudinal Groove
(for Intramedullary Gliding Nails)